

Acid - Alkaline Cabinets



Smoke and Fire Alarm

The storage of caustic materials needs to be controlled. These Cabinets will allow the safe storage of acids and alkalis in a range of highly visible Probe Cabinets.

- Durable epoxy polyester coating giving a surface resistant to most acids and alkalis
- Strong steel construction
- Two point locking on all two door Cabinets
- Removable 75mm sealed sump base tray
- High visibility 270 degree labelling complying to BS5499-1
- All Cabinets feature adjustable shelves
- Smoke / Fire alarm fitted internally



Medical Cabinets

Under the Health and Safety Regulations 1981, workplaces must have first aid provision. To satisfy a wide range of first aid equipment we have designed an attractive and highly visible range of Probe Cabinets for your working environment.

- Strong robust construction
- All Cabinets feature adjustable shelves
- Two point locking on all two door Cabinets
- High visibility 270 degree labelling complying to BS5499-1
- Reinforced doors for extra strength
- Range of 7 models



W PERSONAL LOCKER
Including top shelf and coat hook

INTERNAL COMPARTMENTS

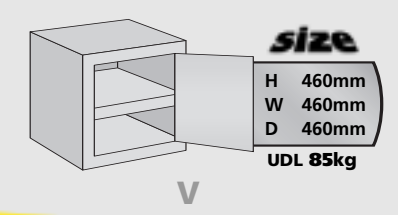
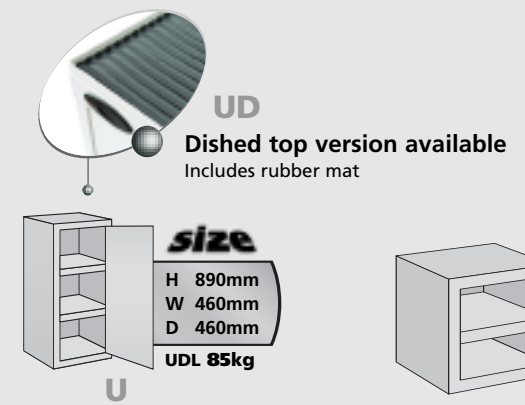
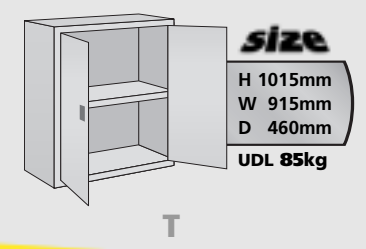

Cabinet Extras

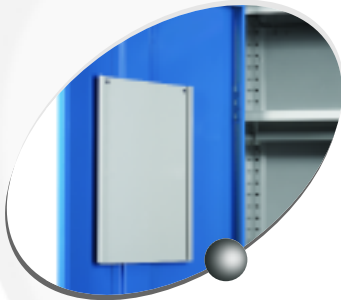

A4 Document Holder
Ideal for keeping track of contents.
Available on all two door Cabinets.

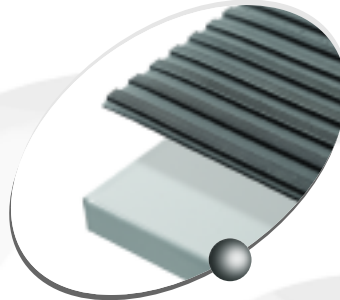

Resistant Rubber Mat
Noise reducing and durable non slip surface. Only available on shelves 900mm x 460mm.



Hasp and Staple
Available on all two door Cabinets where a higher level of security is required. (Padlock not supplied)

Cabinet Features

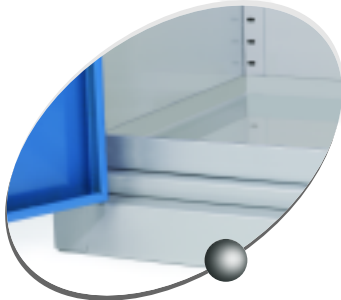

Sump Tray
Sump Tray ensures any spillage is cleanly collected. Standard on all Toxic, Hazardous, Acid/Alkaline and General Cabinets.



Smoke and Fire Alarm
Early warning system where high risk materials are stored. Standard on all Hazardous, Acid/Alkaline and General Cabinets.

Extra Labels

Additional self adhesive labels for all Probe Cabinets are available at a nominal charge.

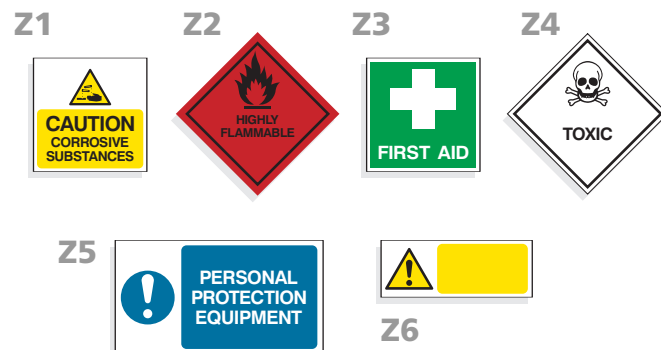

We reserve the right to alter designs and specification of products illustrated in this brochure without prior consent. All sizes are nominal. All information is correct at time of going to press.



THE hard wearing
anti-bacterial powder coating
for the most stringent hygienic environment.

ACTIVECOAT is a new, hard wearing, patent-protected powder coating containing elemental Silver ionically bonded into a bio-compatible ceramic material known as a Zeolite. This impedes the growth and migration of potentially harmful bacteria, mold, fungi, algae and more reducing the risk of cross-contamination from surface to surface. Especially suitable where stringent hygiene standards are required, such as health care, educational, catering and retail changing rooms.

- ✓ 99.9% REDUCTION OF E-COLI & MRSA SUPER BUG
- ✓ INDEPENDENTLY TESTED
- ✓ 100% SAFE TO HUMANS
- ✓ EFFECTIVE FOR THE LIFE OF THE COATING
- ✓ ACTIVECOAT IS AVAILABLE IN ALL PROBE COLOURS

MICROBIOLOGICAL TESTING

ACTIVECOAT has been tested by an Internationally recognised microbiological testing laboratory for antibacterial performance, against the most widely encountered and problematic organisms including the **MRSA Super bug** and **E-coli**. These micro-organisms suffered a **99.9%** reduction in population.

ACTIVECOAT is effective against harmful bacteria including:

- ✗ ASPERGILLUS NIGER
- ✗ STAPHYLOCOCCUS AUREUS (MRSA Super Bug)
- ✗ PSEUDOMONAS AERUGINOSA
- ✗ STREPTOCOCCUS
- ✗ ESCHERICHIA COLI (E-coli)

THE EFFECTIVE LIFE OF ACTIVECOAT

Unlike anti-bacterial sprays and chemical disinfectant which rely on repeated use **ACTIVECOAT** contains anti-bacterial agents uniformly distributed throughout the coating therefore antimicrobial efficacy will continue for the life of the coating.

PROBE PRODUCTS

All Probe products come as standard with **ACTIVECOAT** anti-bacterial powder coating. In addition, all plastic components used in the manufacture of Probe products incorporate a silver based anti-bacterial agent.

PROBE ACTIVECOAT DEVELOPED IN CONJUNCTION WITH DUPONT



The miracles of science™

ACTIVECOAT®

The hard wearing anti-bacterial powder coating for the most stringent hygienic environment.

IRON PHOSPHATE KEY COAT

This anti-rust, key coat bonds to the steel in readiness for the final active coating.

PREPARED STEEL SURFACE

Chemical cleaning ensures an ideal surface for further coatings.

