



Intruder Alarm Kit

IA-210

IA-220

IA-230

Full User Manual



Thank you for choosing the Yale Intruder Alarm System.

This simple to install system has been designed with the user in mind, just follow these simple steps:

Register your product guarantee. Please visit the registration web page and insert the product details. Register your product to get products news and updates.



- 1. Go to Yale web site
www.yale.co.uk/product-registration**
- 2. Complete product information form**
- 3. Activate your guarantee**

if you need extra accessories or spare parts please visit yale.co.uk

Installation Service

Want us to install this product ?

Why not call Yale Smart Security Partners and let a professional installer take care of the rest.

Choose your package online at
www.yalestore.co.uk/installation

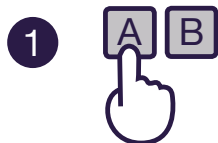

1 Choose your package.

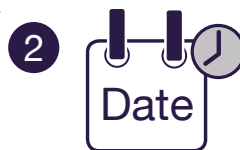

2 Agree a Date & Time



3 Enjoy your professionally installed Yale product!

Install your system in a few easy steps. Please read through all of the steps shown below and then follow the detailed instructions in the following pages. See your box for kit content.

1 Unpack your kit

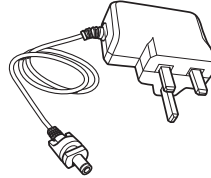
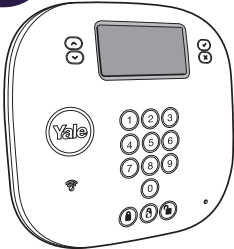
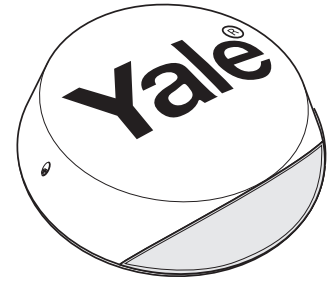
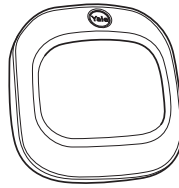

*Each kit contains different components, see your box for kit content.

Page 4.

2 Plan your system

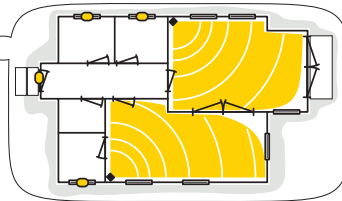
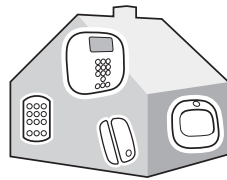

Page 6.

3 Panel set up

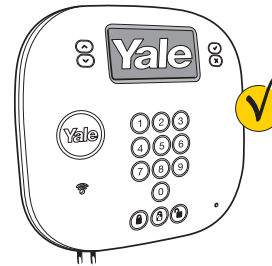
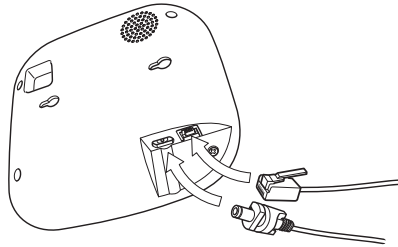

Page 7.

4 Device installation: Activating devices

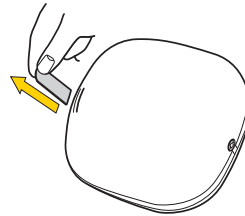
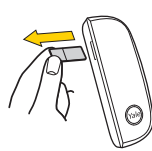

Page 9.

5 Device installation: Testing device signal strength

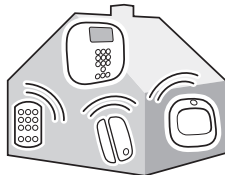

Page 10.

6 Device installation: Install the devices in the desired location

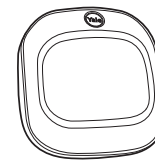
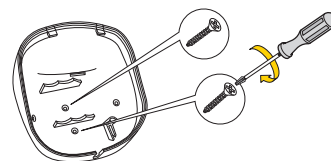
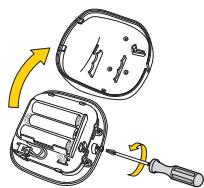

Page 11.

7 Using the system

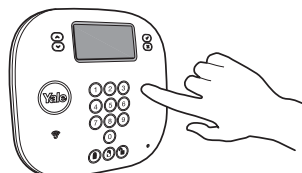

Page 15.

1. Unpack Your Kit.

All the devices in this kit are pre-paired for easy installation. If you are adding more devices (purchased separately to this kit) you will need to pair these into the system separately
See add device section on page 25.

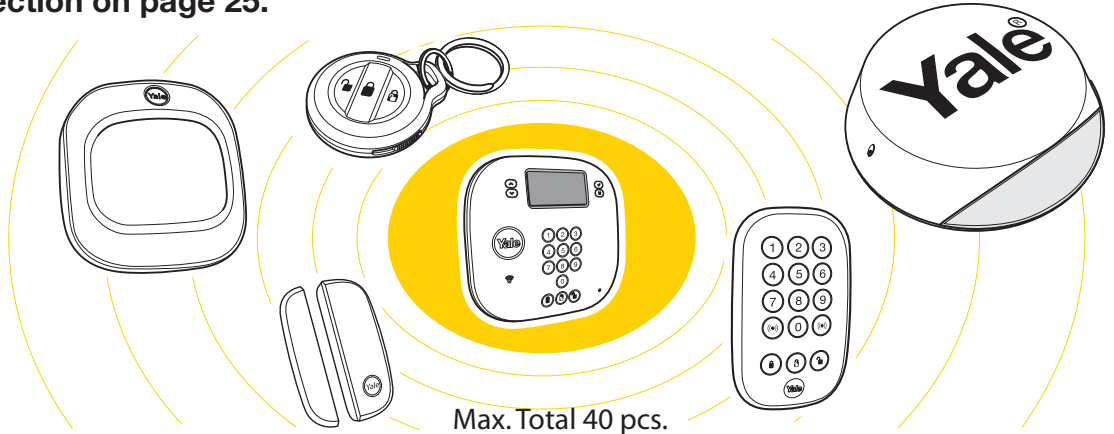
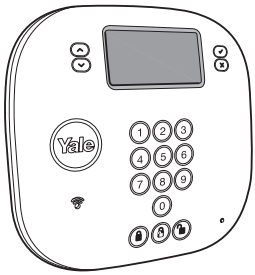

Motion Detector
 AC-PIR
 Available with IA-210, IA-220
 Kit or as accessory

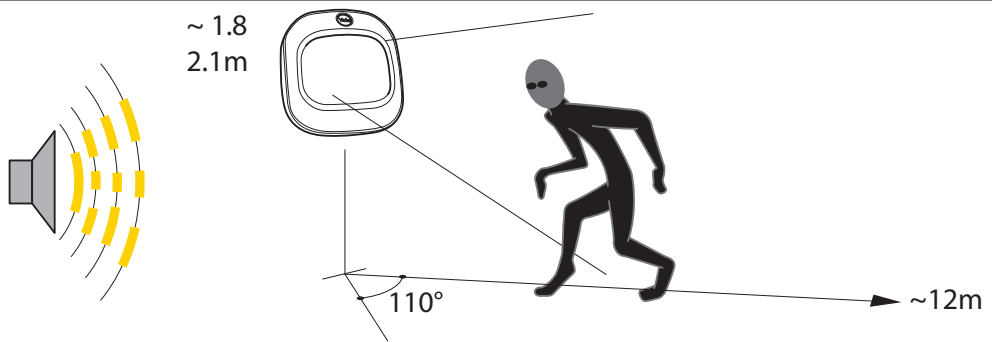

Motion Detector Pet
 AC-PETPIR
 Available with IA-230
 Kit or as accessory

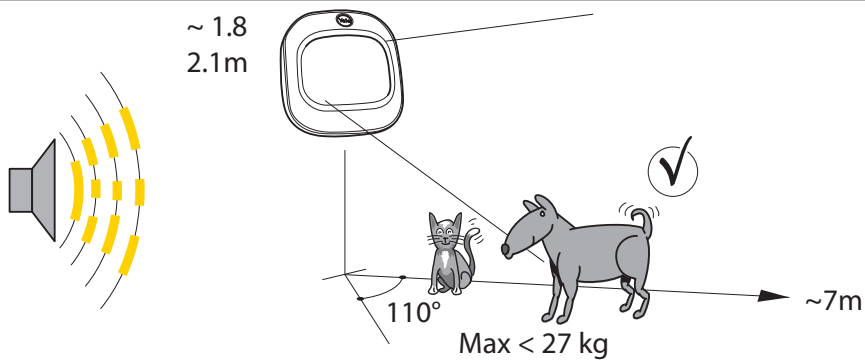
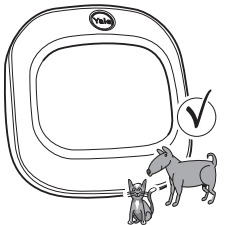

Door/Window contact
 AC-DC

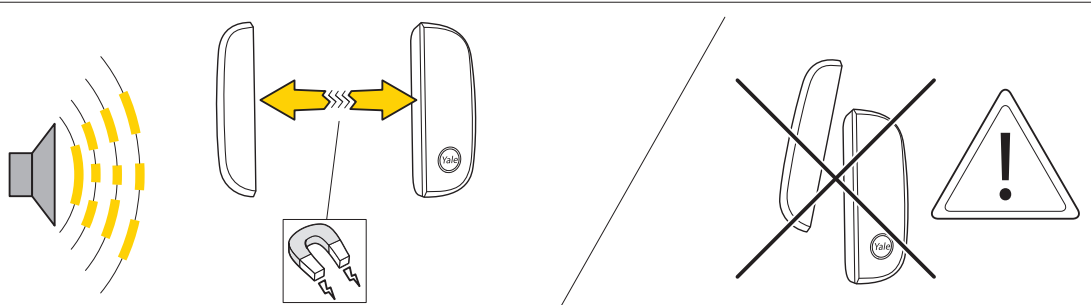
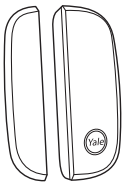

Keypad
 AC-KP
 Available as accessory

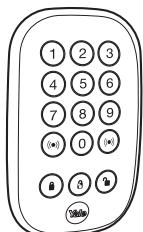

How to Disarm	+ PIN CODE
How to Part-Arm	
How to Full-Arm	



Panic buttons press/hold
 >3sec.<

Panic Buttons can activate your alarm immediately - even when the system is disarmed.

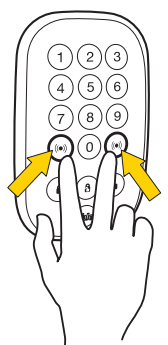

Keyfob
AC-KF
Available with IA-230 Kit
or as accessory

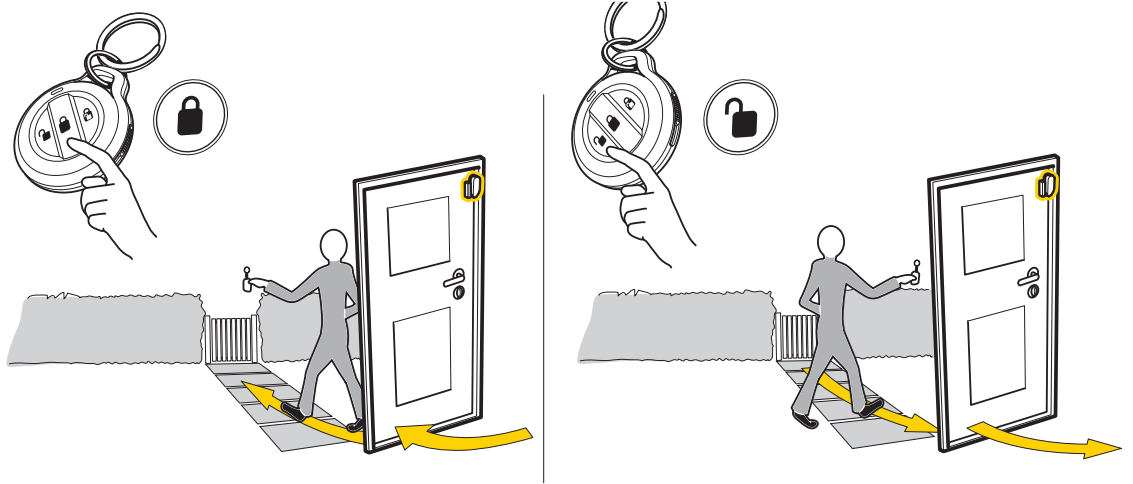

Contactless Tag
AC-RFIDTAG

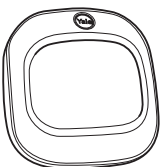
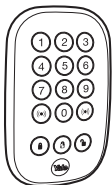
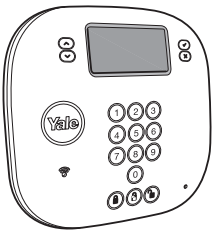
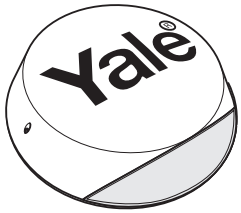

i Most of the devices are provided with either internal or external security tamper mechanism, please make sure the tamper spring is fully compressed when you install the devices.

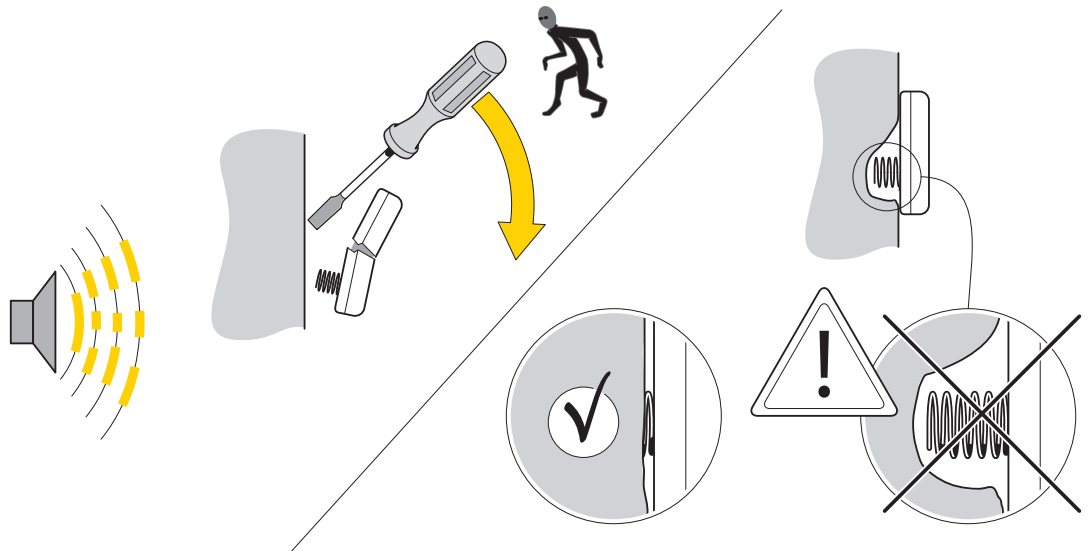

3. Panel Set-up.

1

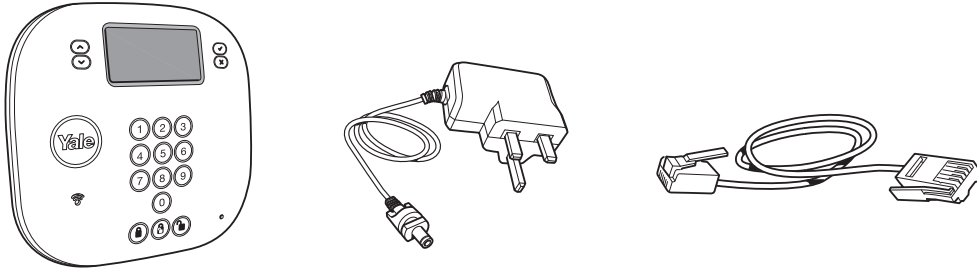

2

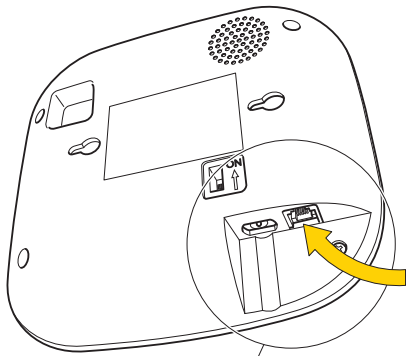

3

Standard PSTN phone landline socket

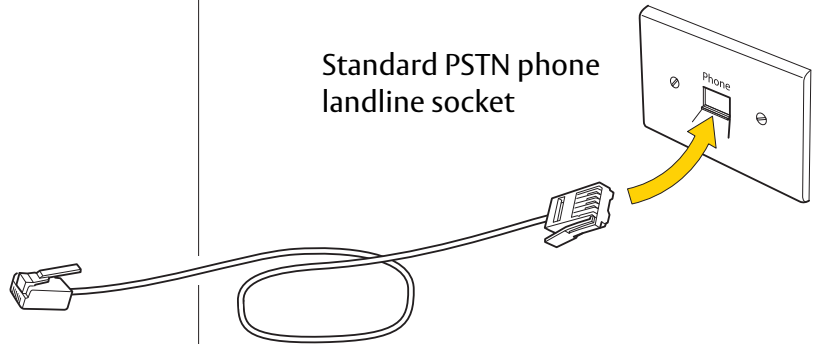

4

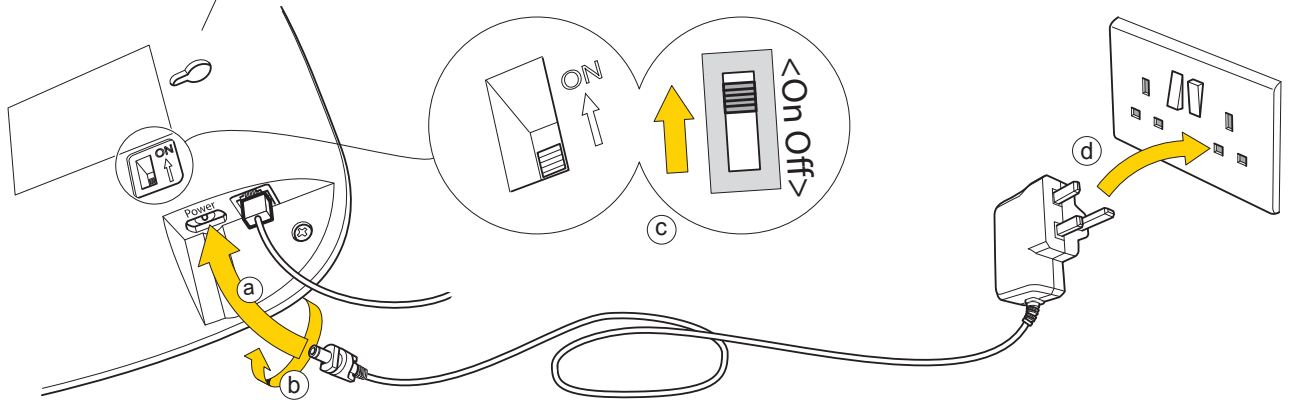

5

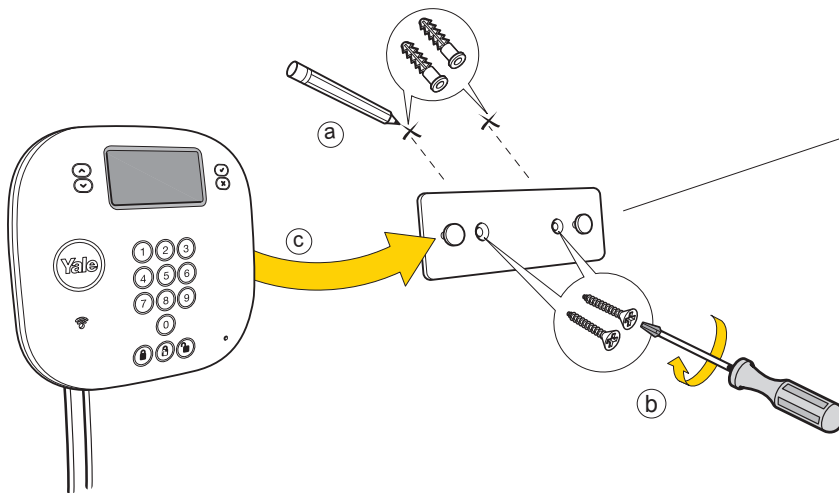

i

The wall mounting holder should be always inserted because the panel has got a tamper switch.

3. Panel set-up.

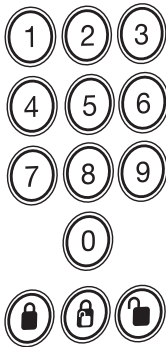

Welcome to your Yale Intruder System
please follow the on screen setup guide.

Press to start setup.

Press to select right setting.

Press to confirm and move to next step.

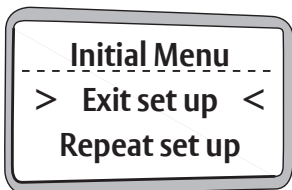

When set up is complete, select:

> Exit set up <

Press to confirm Continue installation

Press + PIN code to exit the set up process

If you wish to repeat the process, select:

> Repeat set up <

Press to confirm

4. Device Installation.

Activate the devices by removing the battery strips. All devices in the kit are pre linked, If you have purchased extra accessories in addition to the kit, you'll need to pair them to the system, following the instruction page 25. 18

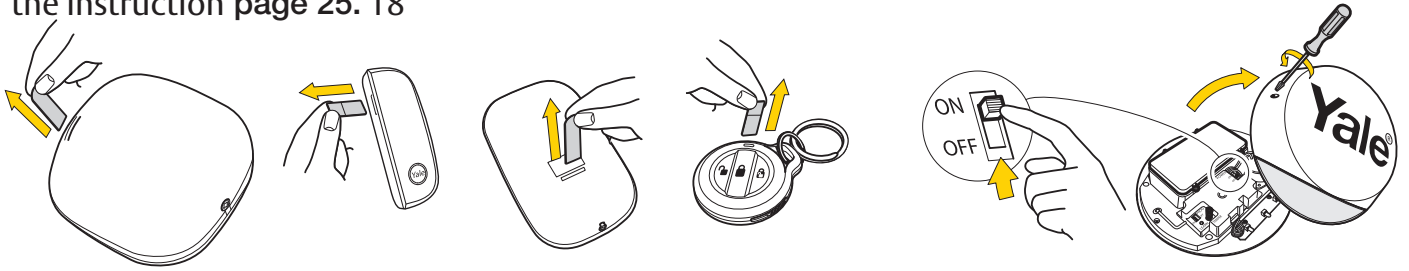

Test your planned location of devices and check the signal strength on the panel screen.

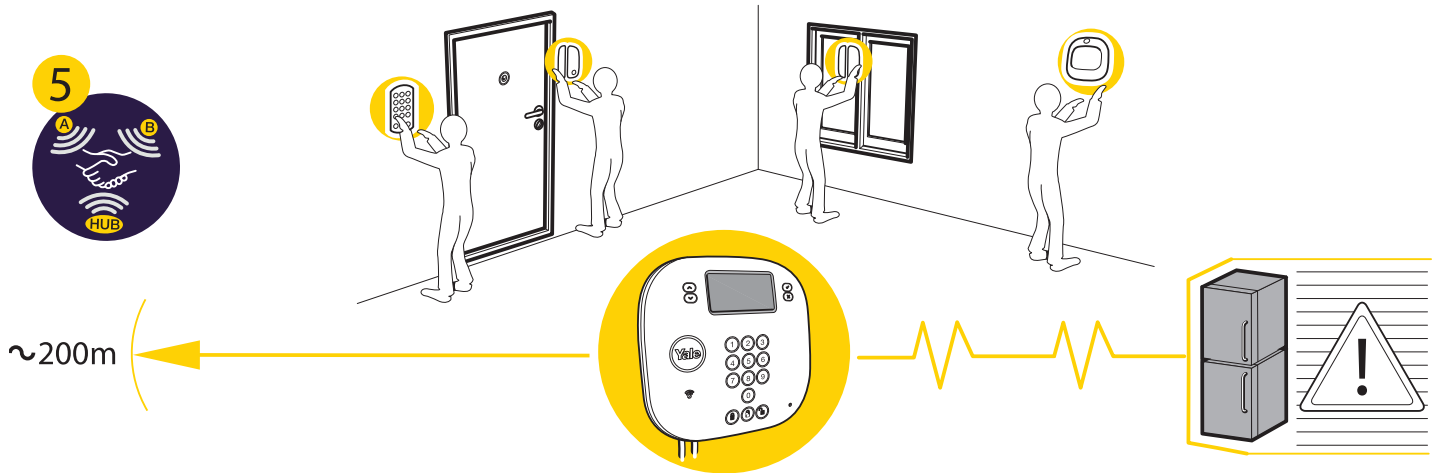

5. Device Installation: Testing Device Signal Strength.

Press  or  button and enter your PIN code to access the main menu

Scroll down using  button and select "Test" and press 

Select "Device" and press  to enter the panel into learning mode



PIR Zone03 E
T:9 PIR 1



If signal strength is below **2** please try to move the device to a different location and repeat connection test.

After all devices have been tested in the desired location -
Press  to exit Test mode

6. Device Installation: Install the devices in the desired location.

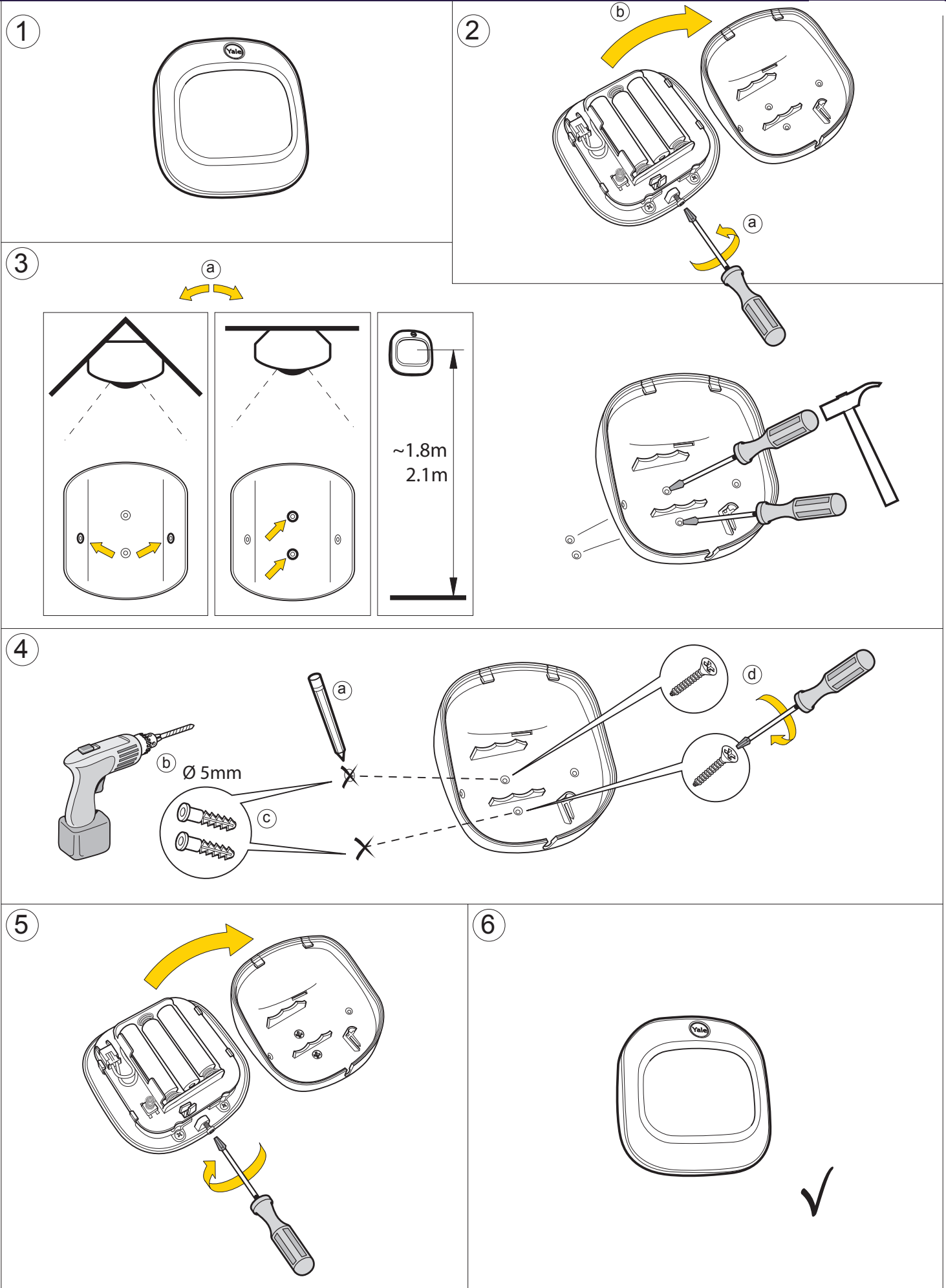

1



2

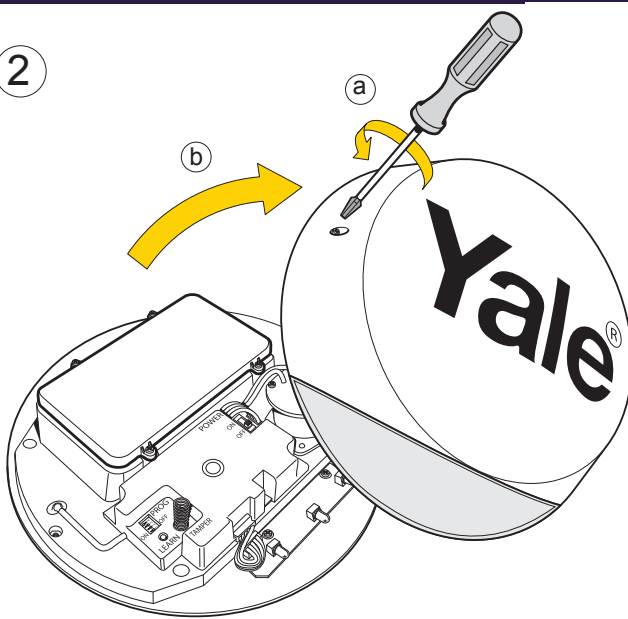

3

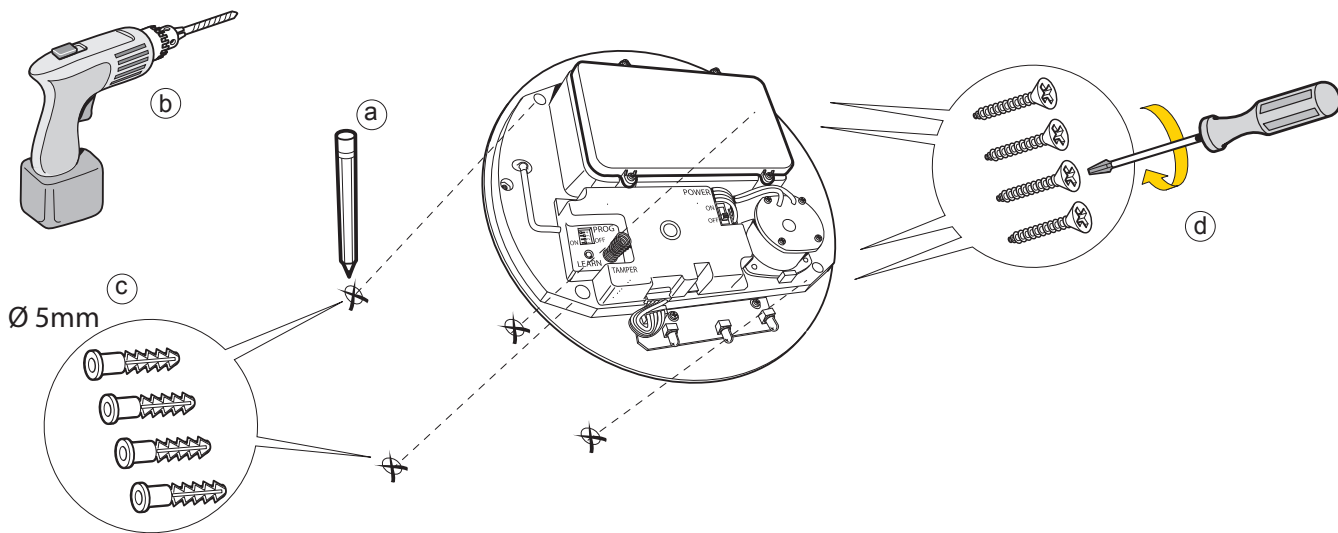

4

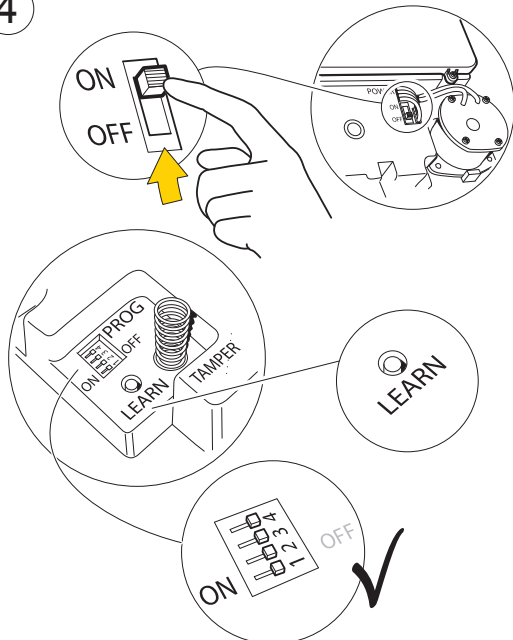

5

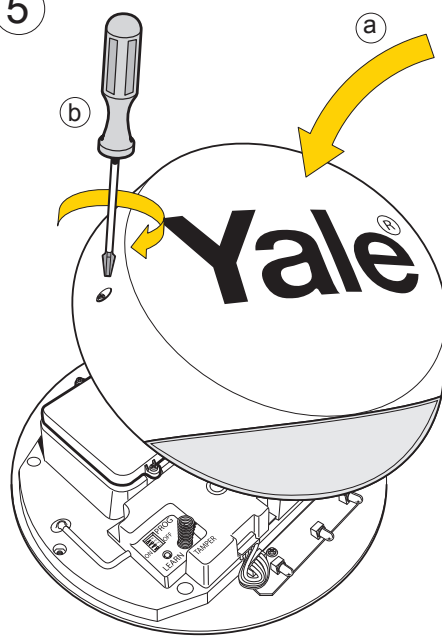

6



6. Device Installation.

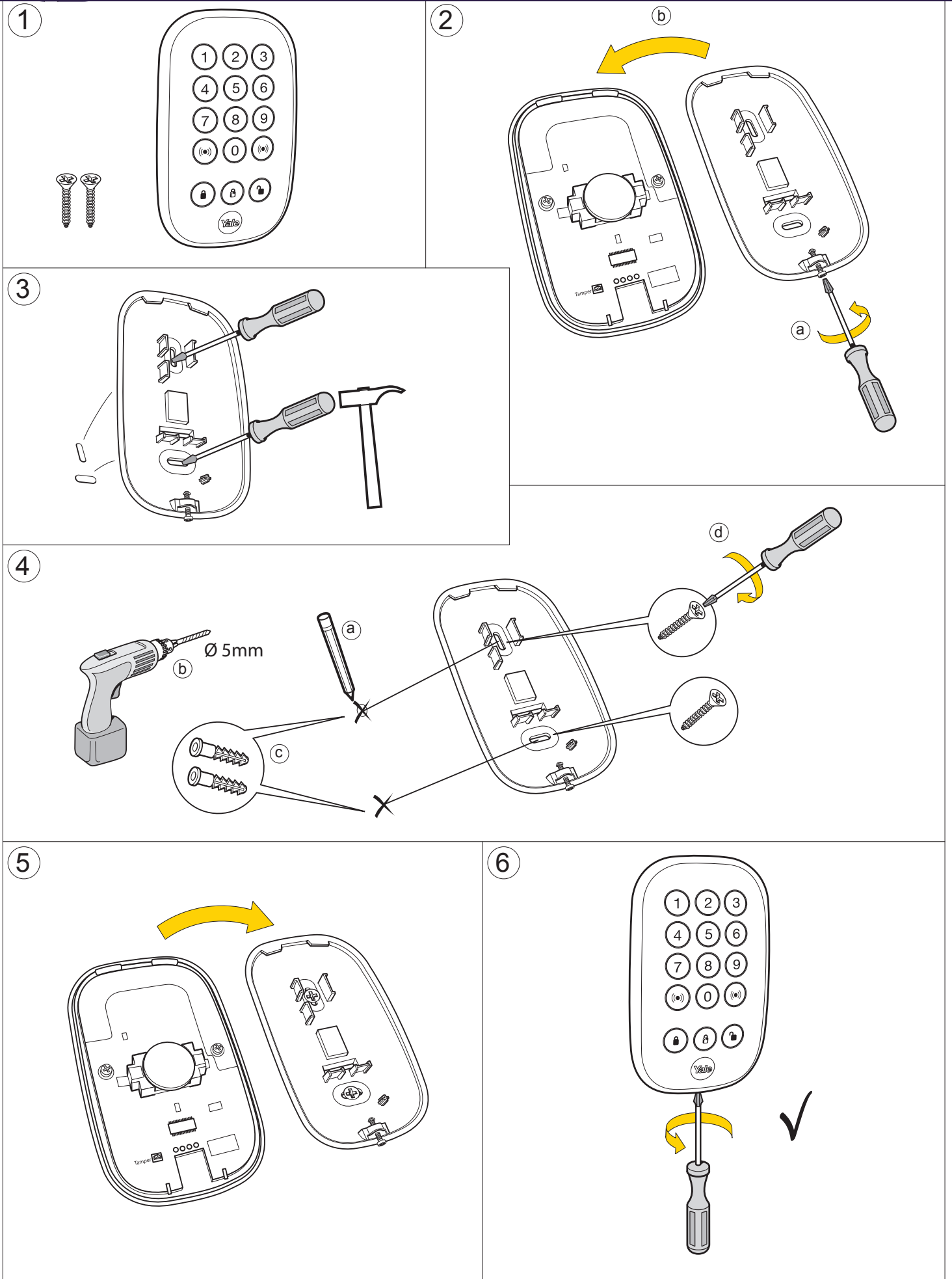

7.Using the system.

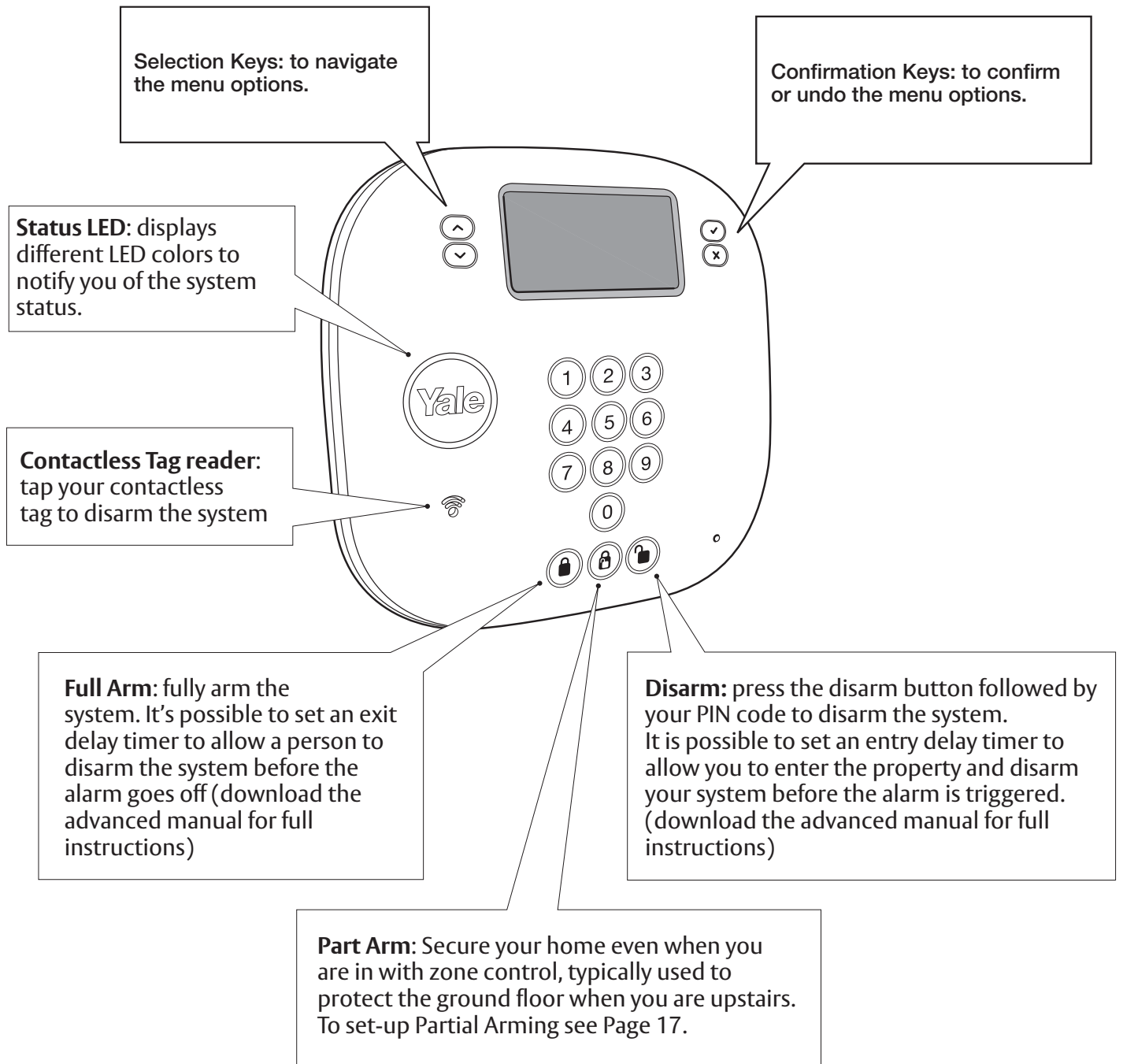

i

When the alarm is triggered the system will auto dial pre-programmed telephone numbers. Please check programming menu details section to find how to set up more telephone numbers, use the telecommunication features and tailor your system to your needs.

7. Control Panel Menu System in Detail.

Entering Programming Mode

The programming mode is for you to configure the system, and make any changes to the pre-set functions.

If the system is in Disarmed (Alarm off) mode, follow the steps below to enter the programming mode.

1. Press ▲▼ key on the Control Panel.
The screen will prompt you to enter the PIN code.

2. Key in your PIN code within 30 seconds.

Note

- Press ✓ to clear the entered PIN. If the code field is empty, it will return to the Alarm Off screen.

3. Press ✓ to continue.

The following message is displayed for 2 seconds.

		P	r	o	g	r	a	m		m	e	n	u		
M	a	k	e		a		s	e	l	e	c	t	i	o	n

4. Then the Programming Main Menu will typically be displayed.

Note

- The cursor is indicated by 2 arrows on both sides of the selected option. It can be moved up and down by pressing ▲▼ respectively.

5. The following items can be selected:

- Set-up
- Test
- System log
- Contactless Tags
- Up/Download

6. After making a selection by moving the cursor to the desired item, press ✓ to confirm the selection. The display will show you the individual programming screen accordingly. Selecting ↺ will return to the Alarm Off screen.

Important Note

- In programming mode, if no key is pressed within 5 minutes, the panel will exit the programming mode and return to the Alarm Off screen.

System Test

When System Test is selected, you will be given 4 different options: Sensor Test, External Siren (test), Panel Siren (test) and Phone alert.

Sensor Test:

Three beeps will sound during a screen self test. This allows you to test the system without causing an alarm. To test the Control Panel is receiving a signal, do one of the following on each accessory that you want to test:

1. Key Pad:-

Press button 8 and 9 together on the Key Pad

2. For all other Accessories:-

Press the test/learn button on the accessories

A chime will sound and the display will show you which device is transmitting. The upper right corner will show the radio signal strength ranging from 1 to 9 (strongest). Relocate the sensor if this is below 5 (unstable).

Ext. Siren and Panel Siren (test):

- The External Siren and Control Panel internal siren can be tested by pressing ✓ when prompted. Press ✓ once more to stop the Siren.

Phone alert:

- Select this option for a test call via phone dialer.

Set Up

This option allow to tailor the system setting to the user needs. You will be given 4 different options:

- Devices
- Part Arming
- Phone Alert
- Advanced Settings

The Part-Arm (Home Arm) mode allows the home to be partially armed so that no one can get inside without first disarming the system. However, the person inside the house can move freely around without triggering the alarm. Part arm mode is usually used to protect the ground floor when you are upstairs in bed.

To enable Home Arm, you will first need to choose the sensors to be ignored during this mode. It would typically be the bedroom PIR etc if you want to arm your system during the night.

Selecting this option, the screen will display with a brief description then press V (Tick) to confirm and the screen will show you a message to press the test button on devices you would like to exclude on Part arm mode.

If you press any test/learn button on any learnt-in sensor (confirm by pressing ✓), these sensors will be excluded during the Home Arm mode.

Repeat this step to exclude additional sensors.

Devices

Select 'Devices' in the set-up programming menu to add or remove a device. From here you will be able to view a list of all the devices being installed and you can add or delete devices. The following items can be selected.

- Add Device
- Edit Devices
- Remove Device
- Program Siren

Add Devices

1. To learn-in a new device select 'Add Device' then press ✓, a "press learn button on device to add" message will be shown.
2. Press the learn button on the device within 30 seconds (see Chapter 2 for location).
3. If a signal is detected, the screen will show the type of device found.

- Devices are labeled by the following codes within the Control Panel:

• Door/Window Contact	DC
• PIR Motion Detector	PIR
• Key Fob	RC
• External Siren	BX
• Key Pad	KP

- When a sensor is added to the system for a second time, an error "Already in System" message will be briefly displayed and the Control Panel will wait for another learn-in signal.

4. Press ✓ to confirm the device type.

5. The following zone types will need setting for Door/Window Contacts and PIR Motion Detectors:

- Burglar
- Home Omit
- Entry
- Away Entry
- 24 Hour (DC only)

The following devices have a fixed **emergency zone type**:

- Smoke Detector
- Key Fob (+Button)
- Panic Button
- Key Pad (2 red buttons)

Zone Type List

Burglar

- When the system is armed and a device is triggered, the alarm will be activated immediately.
- A device set to burglar will not trigger an alarm during entry or exit delay periods.

Home Omit

- A home omit device will be ignored when the system is Home Armed.
- A home omit device will give a burglar alarm when the system is Away Armed.

Entry

- If an entry device is triggered when the system is either Away or Part Armed, it will start an entry delay period to give enough time to disarm the system.
- If the delay period expires without being disarmed, the Control Panel will respond with a burglar alarm.
- If the device has been set to entry and triggered when the system is in disarmed mode, the Control Panel will make a 'ding-dong' door chime sound if the door chime feature is enabled.

Away Entry

- If an Away Entry device is triggered when the system is in Armed mode, the Control Panel will start an entry delay period to give enough time to disarm the system.
- If the delay period expires without being disarmed, the Control Panel will respond with a burglar alarm.
- An Away Entry device is ignored when Home Armed.
- The device will not give a "ding dong" chime sound when door chime is selected.

24 Hour

- The door/Window Contact is the only device that has this zone type, the PIR Motion Detector does not.

- A 24 Hour Door/Window Contact is active all of the time and does not have to be armed or disarmed, if triggered a burglar alarm will be activated immediately.

Emergency

- An emergency device that is active all of the time does not have to be armed or disarmed. If triggered an emergency alarm will be activated immediately.

Edit Devices

To edit all of the devices that has already been installed, choose 'edit devices'. All of the devices included in the system will be displayed.

1. Use ▲▼ keys to scroll the display and choose the device for editing. Press ✓ to select.

2. After confirming the zone type (if available), you are now asked to enter a name. Press ✓ to confirm or X to cancel without naming.

- Each device can be given a 12 character name. Names can be given either when first adding a device or by editing them later.
- When the "Enter Zone Name" screen is displayed the numeric keyboard can be used to enter text. Simply find the corresponding numeric key with the required character and press repeatedly until the wanted character appears. Release the key and the flashing cursor automatically jumps to the next position for you to continue with the next character by the same method.

- The keys have the following functions:

- 1 1
- 2 2ABCabc
- 3 3DEFdef
- 4 4GHIghi
- 5 5JKLjkl
- 6 6MNomno
- 7 7PQRSpqrs
- 8 8TUVtuv
- 9 9WXYZwxyz
- 0 0 <space>/&'.'"+
- ↵ Backspace and delete

- The name can be erased by clearing the display by pressing X repeatedly, followed by ✓.

4. Press ✓ when completed to confirm the name and return to the device list.

Remove Device

To delete a device choose 'remove device' in the "Edit device" menu. A list of all programmed devices

will be shown.

1. Use ▲▼ keys to select the device you wish to delete and press ✓.

- 2 The selected device will be displayed again, press ✓ to confirm deletion or X to return to the device list without deleting.

- If a device name has not been programmed the screen will show the preset zone number instead.

Program External Siren

To program the Siren, select 'program Siren' in the "Edit device" menu. The following items are available in this menu:

- Siren Tamp. On
- Siren Tamp. Off
- Confirm On
- Confirm Off
- Entry Snd On
- Entry Snd Off
- Comfort LED

External Siren Tamp. On, Siren Tamp. Off

The External Siren tamper switch can be enabled and disabled remotely.

- The External Siren tamper protection automatically switches back on after one hour.

Confirm On, Confirm Off

The External Siren can be enabled for Arming and disarming confirmation where one pip and flash is given for arming, with two pips and flashes from side to side for disarming.

Entry Sound On, Entry Sound Off

The entry and exit warning beeps can be echoed on the External Siren.

Comfort LED

If enabled, the External Siren LED will flash periodically according to the set interval. This will reduce the battery life accordingly. Select disable to disable this function (Default Off).

Log

The alarm log memorises the last 30 system events including:

- All alarm events with device names and type
- All fault warning events
- All arming and disarming events
- The logged events are displayed in reversed chronological order (most recent event first).
- The log is marked with a 'start' label before the most recent entry and 'end' after the oldest entry.

To view log:

1. Select the Log menu and press ✓.
2. The log can now be scrolled up and down and viewed with the ▲▼ keys; the most recent event will be at the start.
3. The first line displays the time and date of the event, the second line displays the type of event and the third line either states the user or the device that caused the event. Abbreviations used are:
 - "LB": low battery
 - "Tamp": tamper
 - "R": restore.
 - AC: mains power
 - Panic: emergency
 - Perimeter: entry or away entry device
 - Cancel: silencing an alarm with a Panic Button

Adv. Settings

The settings will initially have factory default values. If you do not want to change them then you can escape any menu by pressing ↶ without making changes.

The following items are available in this menu:

- User PIN Code
- Entry Time
- Exit Time
- Entry Sound
- Exit Sound
- Door Chime
- Door Open/Close
- LCD Backlight
- Key Tone
- Ring Tone
- Alarm Length
- Panel Siren
- Jamming Det
- KF Entry
- Tamper Alarm
- Mobility CHK

- Siren Delay
- Warning Beep
- Time
- Date
- Supervision
- Final Door

PIN Code

The PIN Code (password) is used to configure the Control Panel and to disarm the system.

- To disarm, press the 'disarm' key followed by your PIN code.
- To enter the program menu press the '▲▼' key, enter a PIN code followed by ✓.
- Up to 6 PIN codes can be stored.

1. Select 'PIN Code' then press ✓, a list of 6 PIN codes will be shown, occupied codes are shown with ****. The list can be scrolled up and down using the▲▼ keys.
 2. Select the code you want to change and press ✓, enter your new PIN code and press ✓. You will be asked to repeat the PIN code, enter it again and confirm by pressing ✓, the new code is now programmed.
- X can be used to correct entry errors, pressing X repeatedly will return you to the PIN code list.
 - User 1 code can only be changed and cannot be erased. All other codes can be enabled/disabled by selecting them and pressing arm key.
 - An error message will be shown if either an incorrect repeat code is used or a duplicate code is entered for another user. All codes have to be different.

Entry Time

Note: Ensure device is set to entry on Control Panel for the entry time to work (see section 5, Add Devices)

Entry time gives you a delay to allow you time to enter your premises and disarm the system. Times can be set from 00 seconds (no delay) up to 70 seconds in 10 second increments.

- 20 seconds is the factory default.

Select using the selection keys, if you want to set entry time for Away or Part Arm mode and press ✓

Exit Time

Exit time gives you a delay to allow you leave you premises before the system arms. Times can be set from 00 seconds (no delay) up to 70 seconds in 10

premises before the system arms. Times can be set from 00 seconds (no delay) up to 70 seconds in 10 second increments.

- 30 seconds is the factory default.

Select using the selection keys, if you want to set entry time for Away or Part Arm mode and press V

✓

Entry Sound

The Control Panel will beep during the entry delay period as an entry warning, you can switch the sound on and off with this setting.

- Entry sound on is the factory default.

Exit Sound

The Control Panel will beep during the exit delay period as an exit warning, you can switch the sound on and off with this setting.

- Exit sound on is the factory default.

Door Chime

Any Door/Window Contact or PIR Motion Detector set to entry will cause the Control Panel to chime when activated when the system is disarmed. This is used to signal when someone has entered your premises. You can switch the sound on and off with this setting.

- Chime off is the factory default.

DC Open/Close

If this is turned On, the Control Panel will sound a door chime and display a fault message when user tries to arm the system with Door/Window Contact opened.

- DC Open/Close Off is the factory default.

LCD Backlight

The Control Panel display LCD can be turned on Permanently or set to auto turn off after 30 seconds of last key pressed.

- Auto off is the factory default.

Key Tone

The Control Panel can be made to beep when a key is pressed. Key Tone can be selected to On or Off.

- Key Tone On is the factory default.

Ring Tone

The Control Panel can be made to beep when the phone is ringing, you can switch the sound on and off with this setting.

- Ringing off is the factory default.

Alarm Length

The Siren (both external and built-in) will sound when an alarm is activated. The length of the alarm can be set from 1 to 10 minutes in 1 minute increments with this setting.

- 3 minutes is the factory default.

Panel Siren

You can disable the Control Panel's built-in siren with this setting.

- Siren on is the factory default.

Jamming Det

Enable or disable Jamming/Interference detection on the Control Panel. Confirmed by pressing the ✓ key. Default setting is Disable (recommended).

KF Entry

When selected as Off, user must first trigger an entry sensor before the Key Fob can disable the system. Please select On if you which to disarm the system without first triggering an entry sensor.

- KF Entry Off is the factory default.
- If the Key Fob's panic button is triggered, the same Key Fob cannot be used to silence the External Siren.

Tamper Alarm

If set to Away Arm only, it will trigger the alarm when tamper is active under Away Arm mode (also known as Full Arm). It will only give a fault LED indication in all other mode. If set to Normal, a tamper condition will always triggers a burglar alarm under Disarm, Home Arm and Away Arm mode.

- Away Arm Only is the factory default.

Mobility CHK (for elderly or infirm)

If there is no movement around the house for a preset period of time (from home omit sensors under Part Arm and all sensors under disarm mode), an emergency alarm will be activated and reported over the telephone line. Any key pressed on the Control Panel and entry sensor triggering will reset the countdown timer. The monitoring can be disabled or set at 4, 8 and 12 hour.

- Disable is the factory default.

Siren Delay

This setting allows a delay before the Control Panel and External Sirens are activated. You might want to use this if you do not want the Control Panel to draw attention to itself during an alarm, to give it time to dial out on the telephone line. The delay can be set from Disable (no delay) to 10 minutes in increments of 1 minute.

- Disable is the factory default.

feature to be switched on and off.

- Warning on is the factory default.

Time

The Control Panel uses a 24 hour clock. The time is set by using the ▲▼ keys and confirmed by pressing the ✓ key.

Date

The day and month are set by using the ▲▼ keys and confirmed by pressing the ✓ key.

Supervision

Enable or disable supervision detection on the Control Panel. PIR Motion Detector, Door/Window Contact, Smoke Detector and External Siren can be monitored for outage using this feature. With the exception of the Smoke Detector (which is always on), the other three accessories need to have supervision enabled on board to facilitate this feature.

- Default setting is Disable (recommended).

Final Door

If this is turned On, a system counting down under the full arm mode will immediately arm when user exit and triggers the Door/Window Contact's close position (Applies to door contact with "entry" attribute only).

- Final Door Off is the factory default.

Tel. Settings

This menu allows you to program up to 3 telephone numbers, record an address message and place test calls. The following items can be selected.

- Tel. Numbers
- Rec. Address
- Test Report

Tel. Numbers

This menu has a list of 3 telephone numbers. These numbers are dialed in order, a maximum of 20 digits per number can be stored. Only one number is required to enable the Control Panel to report over the telephone line.

1. Use the ▲▼ keys to select a number from the list.
2. Press ✓ to confirm. If there was a number already stored then you will be asked to change the number, if the slot was empty you will be asked to enter a new number, confirm by pressing ✓.
3. Enter your phone number and confirm by

pressing ✓. Press "Up arrow" key for * key (insert 3 seconds time gap, useful for switchboard) and "Down arrow" key for the # key.

- Errors can be corrected by pressing ⏪ to backspace, pressing ⏪ repeatedly will take you back the telephone number list. Telephone numbers can be deleted in the same manner.

Rec. Address

This menu allows the recording of your address. The maximum length of message is 10 seconds which is ample for most messages, when recording remember to speak clearly and slowly into the microphone.

1. Press ✓ and you will be either asked to record a new message or change an old one.
2. Press ✓ again and follow the on screen instructions. When you finish recording remember to press ✓ to stop recording. If you go over the 10 second recording time (indicated by a beep) just repeat the recording procedure again taking care not to go over the 10 second time limit. The recording is complete.

Test report

This menu allows you to test the telephone reporting feature.

- Please check with the call recipients before making a test call.
- Ensure that the phone cord is connected.

1. Select Test report and press ✓.
2. A list of numbers will be displayed, select the number you want to test and press ✓.
3. The Control Panel will now display call progress.
 - The address message and pre-recorded emergency, burglar and acknowledgement request messages will be played in a loop for 85 seconds.
 - The test can be cancelled at any time by either pressing the ⏪ button or the call recipient pressing "9" on their phone to acknowledge the call. If a radio DECT or mobile phone is used, remember to press 9 repeatedly until the call closes.
 - Check that the call has been successfully received.

8. Using the system.

Arm and disarm the system and practice using it. Trigger the alarm by arming the system and opening protected door/windows and walking past PIRs. Now is the time to show the rest of the family how simple it is to use.

i The PIR Motion Detectors have a built-in sleep timer to save battery power. If there is no motion in front of the PIRs for 1 minute, the PIRs will become 'ready to signal' and motion will now be reported. The PIRs will sleep for 1 minute after reporting.

Any motion detected in sleep time will not be reported and will extend the sleep period by a further 1 minute.

Away Arm

Arming the System

1. When the system is disarmed (alarm off), press the Arm key on the Control Panel, Key Pad or Key Fob.
2. The Control Panel will start its countdown.
3. When the exit delay time is up, the Control Panel will sound a long beep. The External Siren will beep once and the strobe will flash once after the exit delay has expired. 'Alarm on' will be displayed on the screen and the system is now in Away Armed.
4. If there are faults within the system, i.e. the tamper switch of a sensor left opened, the user will not be able to arm the system with a single press. The user can use the Control Panel, Key Pad and Key Fob to force arm the system by pressing Arm twice.

Stopping the Exit Delay by Disarming

1. Press the disarm key on the Key Fob or press the disarm key followed by a PIN code on the Control Panel and Key Pad.
2. 'Alarm off' will be displayed on the screen and the system will return to disarmed mode.

Extending the Exit Delay

- The exit delay time can be extended during the exit delay period by pressing the arm button on the Key Pad or Key Fob. Each time the Arm button is pressed, the delay time starts counting from the beginning.

Alarm Activation

- If any Door/Window Contact or PIR Motion Detector set to entry or away entry is triggered, the entry timer will be started. If the entry timer is allowed to expire and alarm will be activated.
- If other sensors not set to entry or away entry is triggered, the alarm will be activated immediately.

Disarm

Disarming the System

1. Press the Disarm key on the Key Fob or press the disarm key followed by a PIN code on the Control Panel and Key Pad. You can also tap the contactless tag on the panel to disarm.
 - The Key Fob only will only disarm the system during entry time after an entry or away entry Door/Window Contact or PIR Motion Detector has been triggered.
2. The Control Panel will sound a long beep. The External Siren will beep twice and the strobe will flash side to side. 'Alarm off' will be displayed on the screen and the system is now disarmed.
3. The Control Panel will lock out for 5 minutes if the PIN code has been entered incorrectly five times.

Part Arm

The Home Arm mode allows the home to be partially armed so that no one can get inside without first disarming the system. However, the person inside the house can move freely around without triggering the alarm. Home mode is usually used to protect the ground floor when you are upstairs in bed.

Arming in Part Arm Mode

1. When the system is disarmed (Alarm off), press the Home Arm key on the Control Panel, Key Pad or Key Fob.
2. The Control Panel will start its countdown.
3. When the exit delay time is up, the Control Panel will sound three short beeps. The External Siren will beep once and the strobe will flash once after the exit delay has expired. 'Home' will be displayed on the screen and the system is now in Home Armed.
4. If there are faults within the system, i.e. the tamper switch of a sensor left opened, the user will not be able to arm the system with a single press. The user can use the Control Panel, Key Pad and Key Fob to force arm the system by pressing arm twice.

Extending the Exit Delay

- The exit delay period can be extended in a similar manner as described in Away Arm.

Alarm Activation

- If any Door/Window Contact or PIR Motion Detector is triggered, the entry timer will be started. If the entry timer is allowed to expire and alarm will be activated.

- Home Omit and away entry sensors will be ignored.
- If other sensors not set to Home Omit, Entry or Away Entry are triggered, the alarm will be activated immediately.

Stop the Alarm and Alarm Display

During an alarm, the Control Panel and External Siren will sound and dial the emergency phone number.

Stopping the Alarm

1. Press the disarm key and enter a user code on the Control Panel or Key Pad. You can also tap the contactless tag on the panel to disarm. The Control Panel will sound a long beep and display the device that caused the alarm. The External Siren will beep twice and the strobe will flash side to side.
 - The Key Fob cannot stop an alarm caused by burglar or emergency device.
2. When the Control Panel is displaying the source of the alarm, pressing any key will display the telephone number that it dialled out and acknowledged (if any). If there were more than 2 numbers that were acknowledged the numbers will be shown by pressing further keys.
3. When "Alarm off" is displayed the system is disarmed.

Alarm Memory

- If an alarm was raised during your absence, and the alarm sequence has been carried out, the screen will continuously show "ALARM! ALARM!".
- Disarm the system as normal.

1 To Clear Alarm Alarm Message

- Light panel up
- Press green/disarm icon
- Enter PIN #
- Press ✓ repeatedly & quickly
- Alarm will double beep and say 'Alarm Off' when reset.

Dialling & Call Acknowledgement

Auto Dialling

- If the system is in Away Arm mode, when an alarm occurs the Control Panel will immediately

dial the preset phone numbers.

- If the system is in Home mode or Disarmed mode when an audible alarm is initiated, the Control Panel will wait for 15 seconds before dialling the preset phone numbers.
- After dialling, the Control Panel will wait 5 seconds then playback the messages in a loop. It will first play the recorded address message then the pre-recorded messages (Burglar, Emergency) depending on the nature of the alarm and finally an acknowledgement request message.
- The recipient should acknowledge the message by pressing '9' on their telephone when prompted.
- Recipients using radio DECT phones or mobiles should press the numbers repeatedly until the call is closed.
- If the Control Panel does not receive an acknowledgement, the messages will be repeated for a period of 80 seconds before attempting to dial again. Each number will have 5 call attempts.
- The Control Panel will continue to dial the number(s) until a call is successfully answered with a '9' acknowledgement.
- System auto-dialling features only operate under tone-dialling method.
- When no telephone number is stored, the Control Panel will not dial out.

Remote Access

The Control Panel allows you to control your system remotely through the telephone line.

1. Dial the phone number associated with the Control Panel.
2. Hang up on the first ring.
3. Wait 5-10 seconds.
4. Dial the number again.
5. The Control Panel will answer the phone on the first ring of that second call.
6. Enter your PIN Code within 3 seconds - PIN Code # 1 only.
7. If the PIN code is correct, you will hear a long beep. A list of different functions is detailed below:

Press 2 Put the system into Away Armed mode (arm the system).

Press 3 Disarm the system.

Press 5 Checking the system status. Long single beep for Away Armed, two beeps for Disarmed and three beeps for Home Armed.

Press 7 Siren on.

Press 8 Siren off.

Press 9 or 0 Disconnect.

- Remember to press 9 or 0 before you hang up, or the Control Panel will hang up automatically after 30 seconds.

i Disabling the system tamper

Before mounting it is important to disable the External Siren and system tamper to avoid the External Siren sounding an alarm.

1. Press the **Menu** key and enter a user PIN code followed by ✓.
 2. The Control Panel is now in programming mode, Select Devices, then Program Siren and Siren Tamp. Off using the ▲▼✓ keys.
 3. Press ✓ when in the Siren Tamp. Off menu and the Control Panel will beep followed by an acknowledgement pip from the External Siren.
 - *Siren programming is described more fully in "Control Panel Menu System in Detail" in section 5.*
 - *The Siren tamper will now be disabled for 1 hour after which it will automatically arm again. If longer is needed to fit the Siren then simply repeat the steps above.*
- **Leave the Control Panel in programming mode to stop the system responding to tampers. If the Control Panel automatically times out, re-enter programming mode again.**

i Enabling the system tamper

After mounting the External Siren and detectors, please enable the system tamper by:

1. Press the **menu** key and enter a user PIN code followed by ✓.
2. The Control Panel is now in programming mode, Select Devices, then Program Siren and Siren Tamp. On using the ▲▼✓ keys.
3. Press ✓ when in the Siren Tamp. On menu and the Control Panel will beep followed by an acknowledgement pip from the External Siren.
4. Quit programming mode and system tamper protection will be automatically restored.

9. Adding and using accessories.

To provide additional protection you can add extra Door/Window Contacts, PIR Motion Detectors, Key Fobs, Key Pads, Panic Buttons and Smoke Detectors. These are available separately from your local stockist.

Adding accessories to your system

1. From the programming menu of the Control Panel, select the Set up, then Devices and press ✓, select 'Add Device' and press ✓ again.
2. Press the Learn button on the device when prompted and confirm it is the correct detector by pressing ✓.

Learn buttons (see Chapter 2 for location):

- Key Fob: Press arm
- PIR Motion Detector: Press the test button
- Door/Window Contact: Press the test button
- Key Pad: Press 8+9 together. The Key Pad needs initialising first, see Key Pad section on the right.

3. Depending on the device learnt in, finish the programming as prompted.

Using your Key Fob

- The Key Fob can be used to Away Arm, Home Arm, and Disarm the system using the buttons as shown.
- An emergency alarm can be activated by pressing the + button for 3 seconds until LED stops flashing.
- An emergency alarm can only be stopped by using a Key Pad.
- The system can only be disarmed after an entry or away entry sensor is activated (in the entry period).

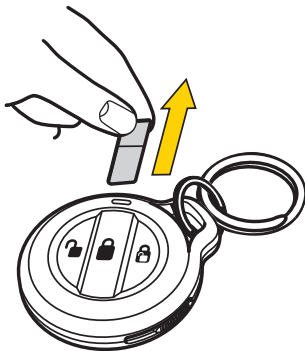

Key Pad

Key Pad initialisation

If you purchase a Key Pad as an accessory, you will need to initialise it prior to use with the Control Panel.

1. Press the 'Panic button A' key followed by factory default Key Pad code '0000' (this is different to your Control Panel PIN code).
2. Press the 'Panic button A' key followed by the '7' key to set the Key Pad into Control Panel system mode (also known as slave mode).
3. The LED will now flash slowly indicating it is in test (programming) mode.
4. Press the 'Panic button A' key followed by the '7' key to set the Key Pad into Control Panel system
5. Quit test mode by pressing the disarm key twice. The Key Pad code and mode setting has been completed. The Key Pad will now use the same PIN code that is set for the Control Panel.

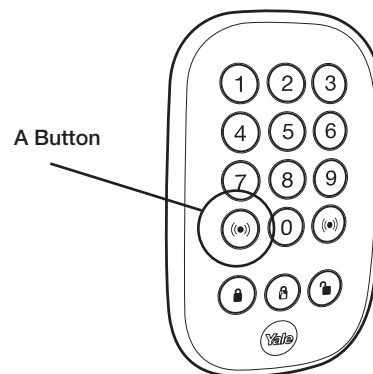

Forgotten Key Pad code (different to Control Panel PIN code)

If the Key Pad code is accidentally forgotten, the Key Pad can be reset to factory default (0000) using the following steps:

1. Unscrew the two Key Pad case screws and remove Key Pad back cover (please disable tamper first). Locate and remove the battery. (See the battery change section page 23)
2. Press the number '4' key at the same time as reinserting the battery.
3. Screw the Key Pad case together and re-learn the Key Pad into the system using the steps described above in this section.

Adding accessories to your system

1. From the programming menu of the Control Panel, select the Set up, then Devices and press ✓, select 'Add Device' and press ✓ again.
2. Press the Learn button on the device when prompted and confirm it is the correct detector by pressing ✓.

Learn buttons (see Chapter 2 for location):

- Key Fob: Press arm
 - PIR Motion Detector: Press the test button
 - Door/Window Contact: Press the test button
 - Key Pad: Press 8+9 together. The Key Pad needs initialising first, see Key Pad section on the right.
3. Depending on the device learnt in, finish the programming as prompted.

Using your Key Fob

- The Key Fob can be used to Away Arm, Home Arm, and Disarm the system using the buttons as shown.
- An emergency alarm can be activated by pressing the + button for 3 seconds until LED stops flashing.
- An emergency alarm can only be stopped by using a Key Pad.
- The system can only be disarmed after an entry or away entry sensor is activated (in the entry period).

Key Pad

Key Pad initialisation

If you purchase a Key Pad as an accessory, you will need to initialise it prior to use with the Control Panel.

1. Press the 'Panic button A' key followed by factory default Key Pad code '0000' (this is different to your Control Panel PIN code).
2. Press the 'Panic button A' key followed by the '7' key to set the Key Pad into Control Panel system mode (also known as slave mode).
3. The LED will now flash slowly indicating it is in test (programming) mode.
4. Press the 'Panic button A' key followed by the '7' key to set the Key Pad into Control Panel system
5. Quit test mode by pressing the disarm key twice. The Key Pad code and mode setting has been completed. The Key Pad will now use the same PIN code that is set for the Control Panel.

Forgotten Key Pad code (different to Control Panel PIN code)

If the Key Pad code is accidentally forgotten, the Key Pad can be reset to factory default (0000) using the following steps:

1. Unscrew the two Key Pad case screws and remove Key Pad back cover (please disable tamper first). Locate and remove the battery. (See the battery change section page 23)
2. Press the number '4' key at the same time as reinserting the battery.
3. Screw the Key Pad case together and re-learn the Key Pad into the system using the steps described above in this section.

Using your Key Pad

- The Key Pad can be used to Away Arm and Home Arm the system using the buttons as shown.
- The system is disarmed by pressing the Disarm button followed by your PIN code.
- An emergency alarm can be activated by pressing the panic A and B buttons simultaneously. Deactivate the emergency alarm by pressing the Disarm button followed by your PIN code.
- The Key Pad uses the same user PIN codes programmed into the Control Panel for disarming.
- To extend the exit time, press the Arm or Home Arm button once more on the Key Pad.

10. Changing the batteries.

Always use alkaline batteries or the correct type of coin cell batteries as replacements because any other battery can cause problems with the operation of the system. Ensure the correct steps are taken when changing batteries in tamper protected devices.

Control Panel Low Battery Indication

The Control Panel will display all device low battery conditions with the exception of the External Siren. This is shown by a fault display with the fault LED lit on the front of the Control Panel.

In addition the devices can also show low battery conditions as described below. When a device first shows a low battery signal it has enough battery capacity to operate for a further month before complete exhaustion.

External Siren Battery Change

When the batteries start getting low the Siren will produce a series of audible pips and flashes during arming and disarming.

1. Switch off tamper protection at the Control Panel using the option available in the programming menu.
2. Remove the External Siren lid and switch the External Siren's power switch to OFF.
3. Unscrew the four screws on the battery compartment lid and remove the cover.
4. Remove the four batteries, wait for 30 seconds, and replace them with four fresh alkaline "D" batteries.
5. Switch on Siren power and check that the Siren beeps and flashes.

Warning: After the batteries have been inserted, the tamper will become active after three hours. Please replace the cover back onto the Siren quickly.

- Siren case tamper conditions are also signalled by a series of beeps when the system is armed but not when the system is disarmed (low battery warning produces a series of audible pips when armed and disarmed), take care not to confuse the two different conditions.
- To check the fault log see page 25

PIR Motion Detector Battery Change

When the battery is low the LED will flash when any motion is detected. The batteries are changed as follows:

1. Put Control Panel into programming mode to prevent a tamper alarm.
2. Loosen the case screw and remove PIR from base to reveal the batteries.
3. Insert 3 x new AAA alkaline batteries observing correct polarity. The PIR LED will flash for 30 seconds while initialising.
4. Refit PIR on base and tighten bottom case screw.
 - Ensure tamper spring is fully depressed when re-fitting the PIR to the back case. If this has not been done correctly this will be indicated by a flashing LED on the PIR.

Door/Window Contact Battery Change

When the battery is low the LED will light up when the Door/Window is opened. The battery is changed as follows:

1. Put Control Panel into programming mode to prevent a tamper alarm.
2. Loosen the case screw and remove Door/Window Contact from base to reveal battery.
3. Gently lever out the old battery.
4. Insert new CR2032 coin cell battery with the + side uppermost. See picture on page 23.
5. Press battery into holder firmly with finger and thumb until a click is heard.
6. Refit sensor on base and tighten bottom case screw. Switch tamper protection back on.
 - Door/Window Contact case tamper conditions are also indicated by a lit LED, check the tamper before changing the battery.

Key Fob Battery Change

When the battery is low the LED will glow dimly when any key is pressed. The battery is changed as follows:

1. Slide the lock slide to unlock the cover. Remove the rubber cover and unscrew to open the case.
2. Insert new CR2032 coin cell battery with the + side uppermost.
3. Replace battery cover.

Press any key and check that the LED lights. If the LED lights the new battery installation is successful.

Key Pad Battery Change

When the battery is low the LED will flash when any key is pressed. The battery is changed as follows:

1. Put Control Panel into programming mode to prevent a tamper alarm.
2. Unscrew the two Key Pad case screws and remove Key Pad back to reveal battery.
3. Using a screwdriver gently lever out the old battery.
4. Insert new CR2032 coin cell battery with the + side uppermost.
5. Press battery into holder firmly with finger and thumb until a click is heard. (see picture below.)
6. Press a number key and check that the LED lights. If the LED lights the new battery installation is successful, screw the Key Pad case back on and the battery change is complete.

Battery Removal and Insertion Key Pad

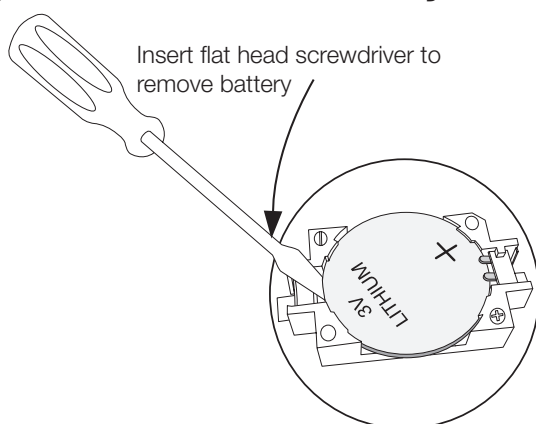

IMPORTANT

Insert the battery under the two tabs and click into place.

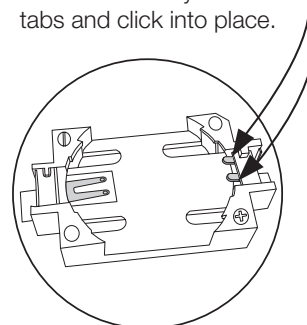

11. Troubleshooting.

External Siren

Siren does not respond to Arming or Disarming

- Siren batteries are completely exhausted. See instructions for changing batteries on page 22.
- Siren not learnt-in. If Siren produces a tamper alarm when the cover is removed and Siren is OK, learn-in the Siren. (see page 12)
- Siren out of range.

Siren produces a 3 second alarm when disarmed

- There has been a previous alarm and there might be an intruder still in the premises.

Siren produces a series of audible pips when armed or disarmed

- If the Siren produces a series of pips when **arming and disarming**, this indicates low batteries. (Change the batteries section.)
- If the Siren produces a series of audible pips **only when arming**, this indicates a tamper fault. Check that the Siren cover is firmly secured and the tamper spring on the back of the Siren is fully depressed when in contact with the wall. If not use suitable packing material to fill gap. (refer to page 8 for diagram)

Siren produces an interrupted tone when sounding an alarm

- The Siren has low batteries. Change batteries with new alkaline replacements. (see change batteries section)
-

PIR Motion Detector

PIR does not respond to motion

- Previous motion has triggered the PIR sleep timer and is preventing subsequent movement detection. Arm system and vacate protected area for at least 90 seconds before testing. By pressing the learn/test button the PIR LED will light up and detect motion for the first minute.

PIR/Motion Detector is slow to respond

- This is normal, the PIR Motion Detector has sophisticated false alarm filtering that will filter out random fluctuations and responds to genuine motion across field of view, it is less sensitive walking directly towards it.

PIR Motion Detector gives false alarms

- Check pets have no access to protected area.
- Check that the PIR Motion Detector is not pointed at sources of heat or moving objects, e.g. fluttering curtains.
- Check that PIR Motion Detector is not mounted above convector heaters or pointing directly at Windows.

PIR/Motion Detector LED flashes

- Batteries are low or the tamper switch is disturbed. Check that the tamper switch spring is making contact with the base. If the tamper switch is OK, change batteries with new AA alkaline replacements. (see page 22)

PIR Motion Detector does not respond to movement

- Batteries are completely exhausted. Change batteries with new AA alkaline replacements. (see change batteries section)
-

Door/Window Contact

Door/Window Contact LED lights up

- Batteries are low or the tamper switch disturbed. Check that the tamper switch spring is making contact with the mounting surface. If the tamper switch is OK, change the battery. (see change batteries section)

Door/Window Contact does not respond to opening when jumper is in test position

- Batteries are completely exhausted. Change the battery. (see change batteries section)

- The magnet is too far away from the Door/Window Contact. Check that the gap between Door/Window Contact and magnet is not greater than 10mm.
-

Control Panel

User PIN code is not accepted by the Control Panel.

- Do not pause for more than 5 seconds in between pressing the keys on the Key Pad.
 - Incorrect code entered. Re-enter the correct PIN code.
 - Reset settings - see 'Reset Procedure' and reprogram the system.
-

Voice - Dialler not responding to alarm

- Check the telephone line is connected and that the correct telephone numbers have been programmed.

LED illuminates and warning beeps (every 30 seconds if enabled)

- There is a fault condition in your alarm system.
Note: this may be a simple fault that can easily be rectified, for example replacing low batteries in a PIR Motion Detector.
- Please view the 'fault log' in the Control Panel to determine what the issue is. This is the first option in the programming menu. First press the 'menu' key and enter your user PIN code followed by pressing ✓. Select 'fault log' followed by ✓. You may need to scroll down using the ▼ Key to check if there are multiple faults in the system. As an example, the display may read 'DC Z01 tamper', in which case you need to check the mounting of the tamper spring on Door/Window Contact zone 01 to rectify this fault. In the case of low batteries, you may see 'IR Z02 LB'. Replacing the batteries in PIR zone 02 will clear this particular fault. Other reported faults include: Interference, Tamper, Radio Device Low Battery and AC Power Fail etc.
- If faults has not been cleared from the 'fault log', a fault display will be show when the Arm or Home Arm keys are pressed, with the device and fault that is causing the problem.
- If more than one fault is present then individual fault messages will be displayed sequentially at 2-second intervals.

IMPORTANT:

Please enter the programming menu first before swapping the batteries- otherwise you will trip the system tamper alarm.

Press the ▲▼ and enter your user PIN code followed by pressing ✓. Stay in the programming menu. Then, disconnect the relevant accessory and replace batteries. If the Control Panel times out and returns to 'Alarm off', please follow the above steps again and repeat the process.

Complete Reset Procedure

Reset to factory default setting

The Control Panel can clear all programmed parameters by the following sequence:

1. Power down Control Panel and turn off the battery.
2. Apply power while holding down the ▲ key.
3. Release the ▲ key when a tone is heard, 'Enter Code' will be displayed.
4. Enter the following key sequence:
▲▼▲▼▲▼▲▼✓
5. Press the X key.
6. All programmed parameters are reset to factory default setting.
7. If more than 17 incorrect keys are entered, then the unit will revert to normal Alarm On mode.

Note

- Once the 'System Reset' is executed, all the programmed data will return to its default value and all the programmed accessories will be removed and the Control Panel will show the initial set up screen. Press the learn button (see Chapter 2 for location) on all accessories one at a time. Every time a button is pressed, the screen will recognise the accessory and you will need to press OK on the panel to acknowledge/add. Please ensure you learn in all accessories before exiting the initial setup screen.

Jamming/Interference Detection

User can enable Jamming/Interference Detection should they feel it is a risk.

Detection via Control Panel

From the panel's menu system, select:
Adv. Setting -> Jamming Det, Enable.

Detection via External Siren

Open up the Siren (Disable tamper first, see page 19) and switch the Dip Switch 2 to On position.

* Enabling these features increases the likely hood of false alarm (false positive scenario).

Alarm Sensor Response Table

	Disarm (GREEN)	Away Arm (RED)	Home Arm (YELLOW)	Exit	Away Arm Entry	Home Arm Entry
Burglar	No action	Instant Burglar alarm	Instant Burglar alarm	No action	No action	No action
Home Omit	No action	Instant Burglar alarm	No action	No action	No action	No action
Entry	Door Chime	Start Entry Timer	Start Entry Timer	No action	No action	No action
Away Entry	Door Chime	Start Entry Time	No action	No action	No action	No action
24 Hour	Instant Burglar Alarm	Instant Burglar Alarm	Instant Burglar Alarm	Instant Burglar Alarm	Instant Burglar Alarm	Instant Burglar Alarm



Customer Service

At Yale, we know the importance of providing security products that are easy to install and use.

However, should you have any questions or experience a problem with your purchase, please visit www.yale.co.uk/help



YaleUK



YaleSecurity



YaleSecurityUK



THE YALE BRAND, with its unparalleled global reach and range of products, reassures more people in more countries than any other consumer locking solution.

THE ASSA ABLOY GROUP is the world's leading manufacturer and supplier of locking solutions, dedicated to satisfying end-user needs for security, safety and convenience.